

****CHECKER LID****

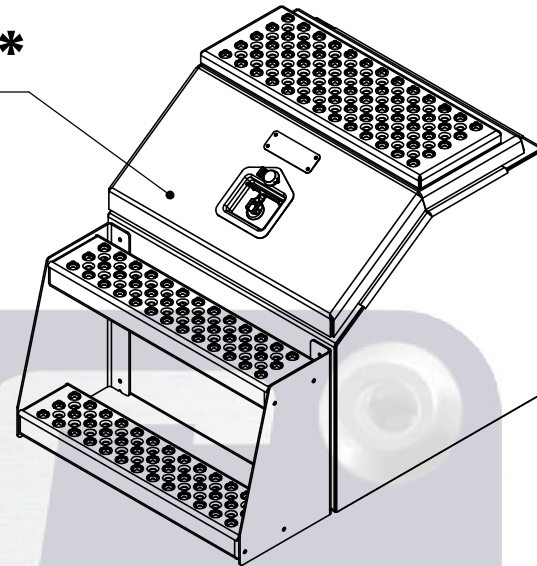

****SWING****

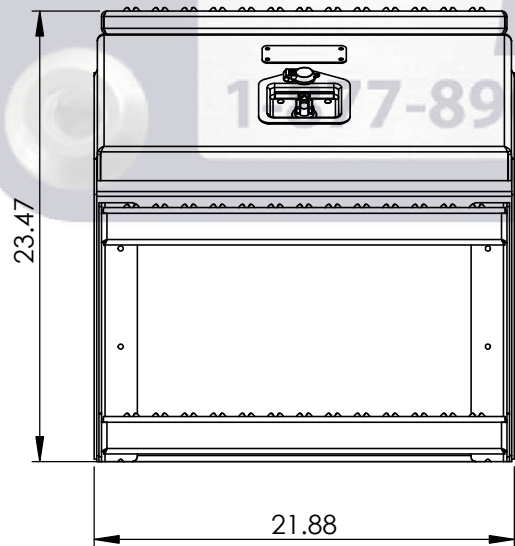
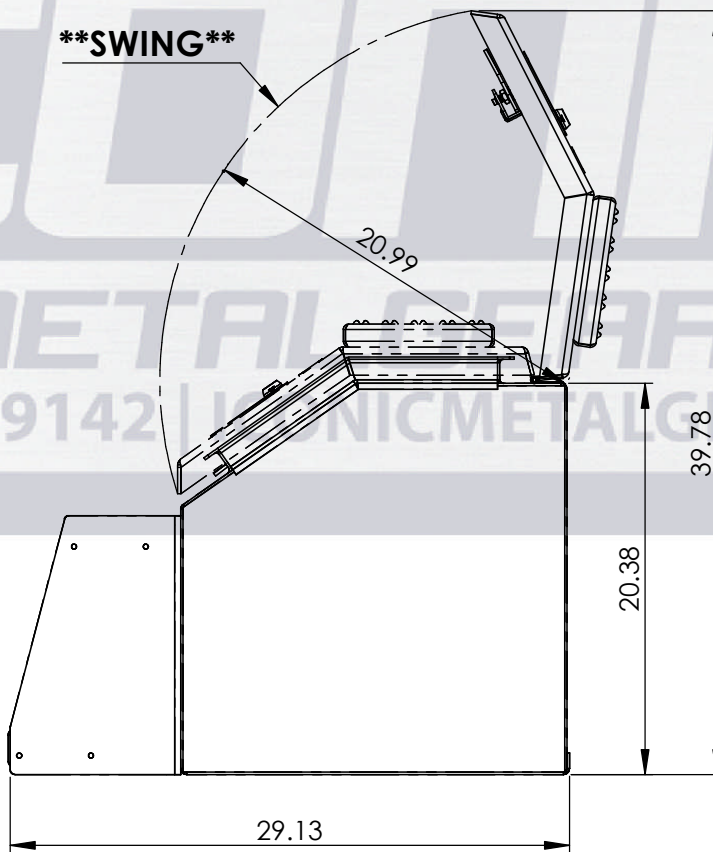

**NOTE:
WHEN MOUNTING,
MAKE SURE TOOLBOX
LID DOES NOT INTERFERE
WITH TRUCK FAIRING.**

Part No.:

1522

MATERIAL: 5052 (Alum)

THICKNESS: 0.125

FINISH: Smooth

DWG. NO.: 3409-0-00-J

Approx. Weight: 43.53 lbs
Surf. Area: 54.52 sq. ft.

ICONIC ELEMENTS (ICONIC METALGEAR) TITLE:

PROPRIETARY AND CONFIDENTIAL
NO PART OF THIS DOCUMENT MAY BE REPRODUCED, STORED IN A RETRIEVAL SYSTEM, OR TRANSMITTED IN ANY FORM, WITHOUT THE WRITTEN PERMISSION OF Iconic Elements Inc. (ICONIC METALGEAR)

22" Big Mouth CH Lid

REV: SHEET:

J 1 OF 1