



WARNING!

REMOVAL OF THIS TAG IMPLIES THAT YOU HAVE READ AND
ACKNOWLEDGE THE INFORMATION STATED BELOW.

IMPORTANT:

AS STATED IN NSC STANDARD 10: CARGO SECUREMENT, DIVISION 5 - FRONT END STRUCTURES - APPLICATION 23(3) - A CAB SHIELD (LIMITED SECURITY/HEADACHE RACK) IS NOT A FRONT END STRUCTURE OR PART OF A CARGO SECUREMENT SYSTEM. THIS HEADACHE RACK IS NOT TO BE USED AS A FRONT END STRUCTURE OR TO SECURE CARGO. ICONIC ELEMENTS INC. MAKES NO REPRESENTATION, EITHER STATED OR IMPLIED, THAT ICONIC METALGEAR HEADACHE RACKS PROVIDE ANY DRIVER OR PASSENGER SAFETY. ICONIC ELEMENTS INC. CANNOT BE HELD LIABLE FOR ANY LOSS, DAMAGE, INJURY, OR DEATH RESULTING FROM SHIFTING CARGO AS A RESULT OF MISUSE, MISAPPLICATION, OR NOT COMPLYING WITH PROPER LOAD SECUREMENT REGULATIONS.

ICONIC METALGEAR HEADACHE RACKS ARE DESIGNED TO OFFER A TRUCK MOUNTED STORAGE SOLUTIONS AND, AS SUCH, HAVE NOT BEEN TESTED AND HAVE NO LOAD RATINGS UNDER THE FMCSA REGULATIONS. AS STATED BY THE FMCSA, HEADACHE RACKS CANNOT MEET THE REQUIREMENTS OF CFR 393.114 (A) AS CARGO MUST BE IN CONTACT WITH THE FRONT END STRUCTURE FOR THE REGULATION TO APPLY. ICONIC ELEMENTS INC. PROMOTES THAT ALL OPERATORS SHOULD BE IN FULL COMPLIANCE WITH ALL OTHER LOAD SECUREMENT REQUIREMENTS AS OUTLINED IN FMCSA 49 CFR 393.100 TO 313.142.

NOTE: IMPROPER USE OF AN ICONIC METALGEAR HEADACHE RACK MAY RESULT IN INJURY OR DEATH. DO NOT USE WHEN HAULING LOGS OR POLES, OR TO SECURE CARGO.

OPERATORS WITH A HEADACHE RACK MANUFACTURED BY ICONIC ELEMENTS INC.:

(A) MUST USE ICONIC METALGEAR APPROVED SYSTEM/MOUNTING KIT.

(B) MUST PERFORM/RECORD REGULAR MAINTENANCE. INSPECT YOUR RACK FOR DAMAGE OR WELD CRACKS, AND CHECK INSTALLATION BOLTS AND TORQUE EVERY 90 DAYS. PERFORM IN CONJUNCTION WITH VEHICLE MAINTENANCE.

(C) MUST USE A NEW, METALGEAR APPROVED, MOUNTING KIT FOR REINSTALLATION.

(D) MUST COMPLY WITH LOAD SECUREMENT REQUIREMENTS AS PRESCRIBED BY FMCSA 49 CFR 393.100 TO 313.142.

**ENJOY THE COMMERCIAL PURPOSE OF OUR RACKS FOR STORAGE,
BUT DO NOT RELY ON THEM FOR ADDING INCREASED SAFETY.**



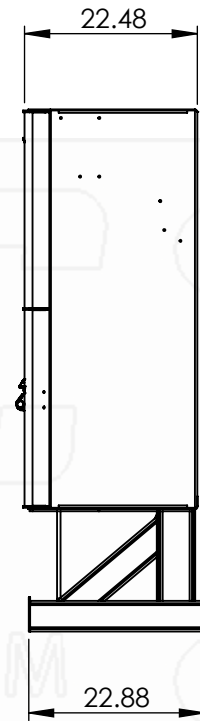
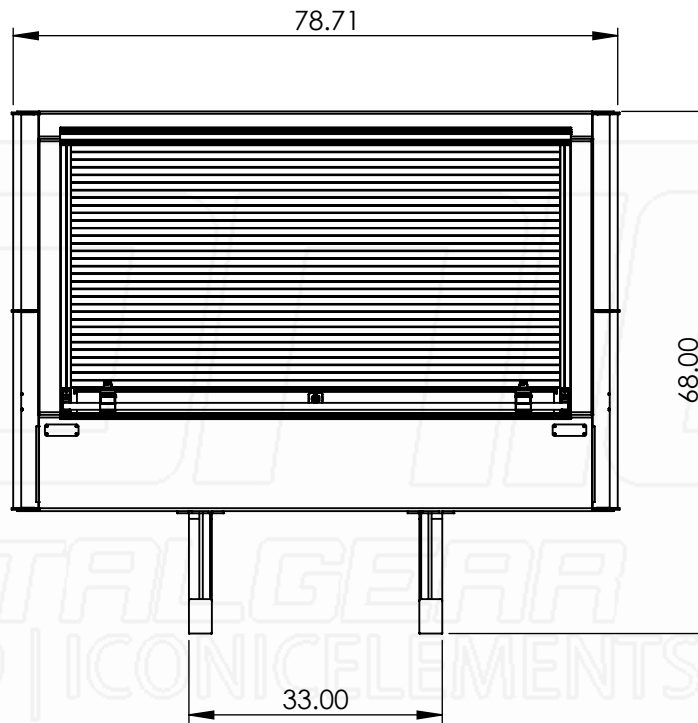
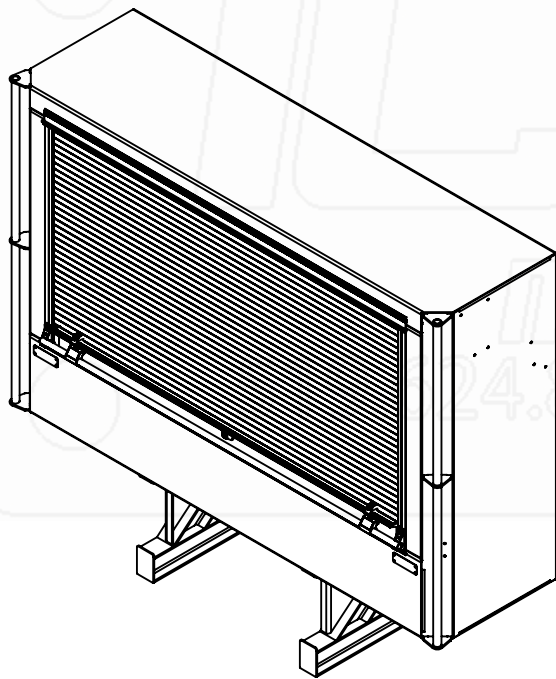

Part No.:

1372

MATERIAL: 5052 (Alum)

Approx. Weight: 339.56 lbs

Surf. Area: 380.32 sq. ft.

THICKNESS: 0.125

ICONIC ELEMENTS (ICONIC METALGEAR) TITLE:

PROPRIETARY AND CONFIDENTIAL
NO PART OF THIS DOCUMENT MAY BE REPRODUCED, STORED IN A RETRIEVAL SYSTEM, OR TRANSMITTED IN ANY FORM, WITHOUT THE WRITTEN PERMISSION OF Iconic Elements Inc. (ICONIC METALGEAR)

FINISH: Smooth

22" Roll Up Rack

DWG. NO.: 3809-0-00-S

REV: SHEET:
S 2 OF 3

5

4

3

2

1

D

C

B

A

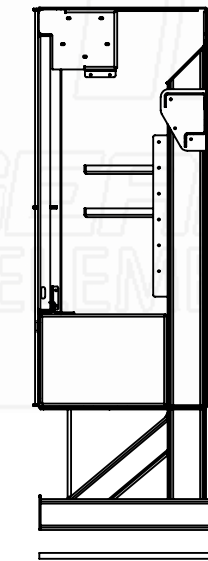
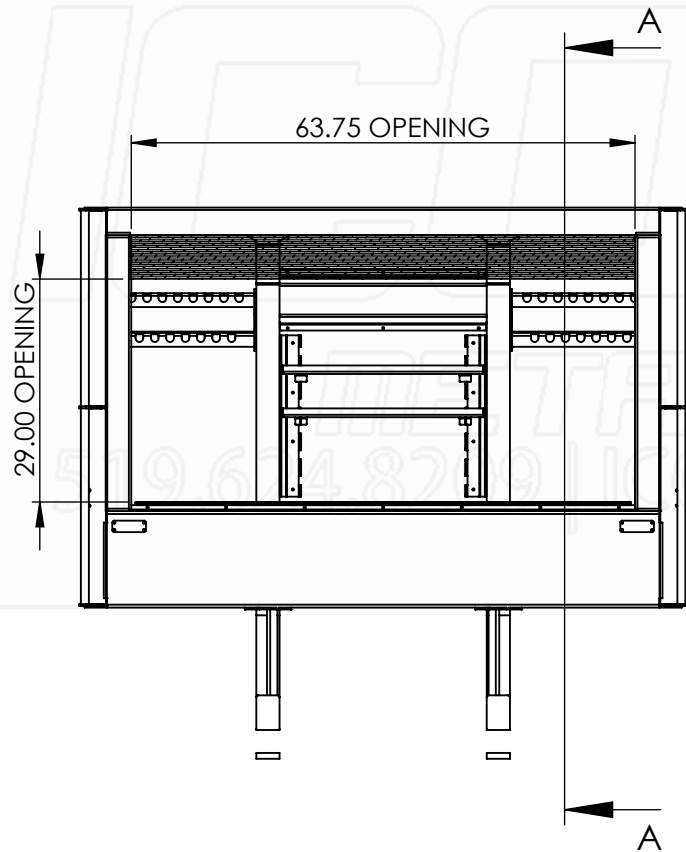

SECTION A-A

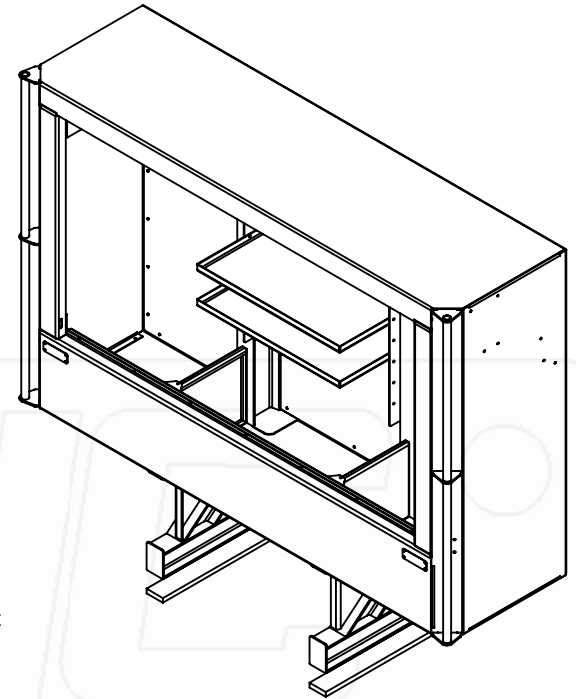

Part No.:

1372

MATERIAL: 5052 (Alum)

Approx. Weight: 339.56 lbs

Surf. Area: 380.32 sq. ft.

THICKNESS: 0.125

ICONIC ELEMENTS (ICONIC METALGEAR) TITLE:

PROPRIETARY AND CONFIDENTIAL
NO PART OF THIS DOCUMENT MAY BE REPRODUCED, STORED IN A RETRIEVAL SYSTEM, OR TRANSMITTED IN ANY FORM, WITHOUT THE WRITTEN PERMISSION OF Iconic Elements Inc. (ICONIC METALGEAR)

FINISH: Smooth

22" Roll Up Rack

DWG. NO.: 3809-0-00-S

REV: SHEET:
S 3 OF 3