

REVISIONS			
REV.	DESCRIPTION	DATE	REV BY
A	Preliminary	2022-07/27	RM

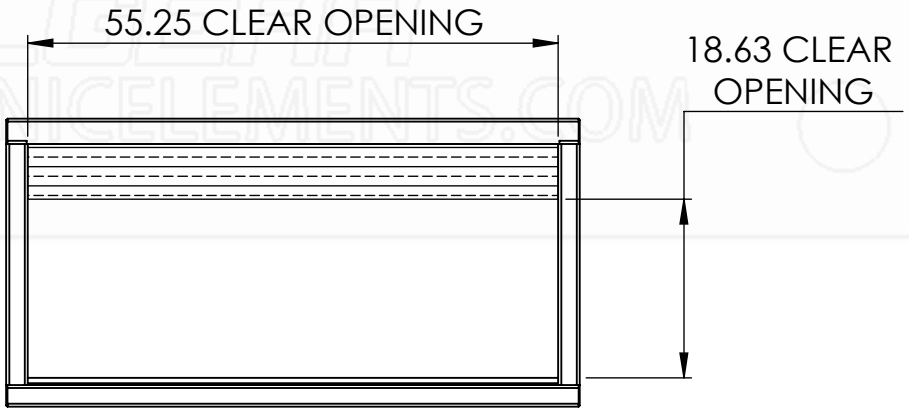
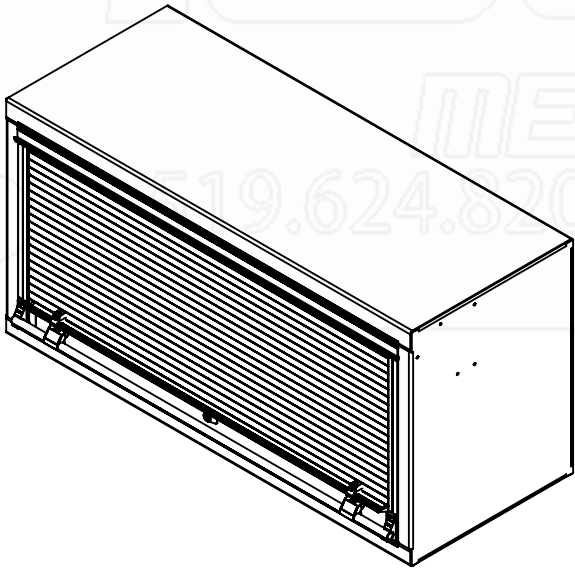
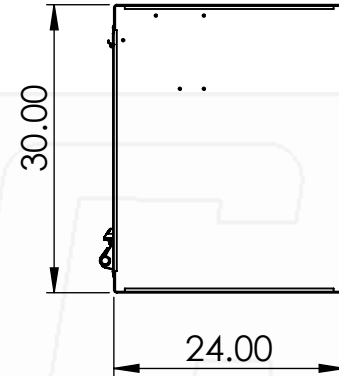
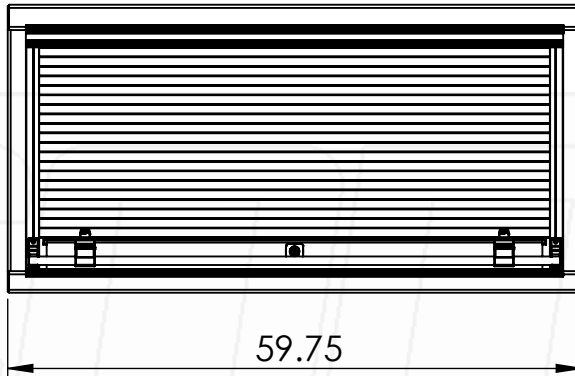

Part No.:	MATERIAL: 5052 (Alum)	THICKNESS: 0.125	FINISH: Smooth	DWG. NO.: 3156-0-00-A
1086	Approx. Weight: 97.38 lbs	ICONIC ELEMENTS (ICONIC METALGEAR) TITLE:		REV: SHEET:
	Surf. Area: 168.78 sq. ft.	<small>PROPRIETARY AND CONFIDENTIAL NO PART OF THIS DOCUMENT MAY BE REPRODUCED, STORED IN A RETRIEVAL SYSTEM, OR TRANSMITTED IN ANY FORM, WITHOUT THE WRITTEN PERMISSION OF Iconic Elements Inc. (ICONIC METALGEAR)</small>		A 1 OF 1
		603024 Roll Up Door Box		

5

4

3

2

1

D

C

B

A